

# 40ft Container Spreader

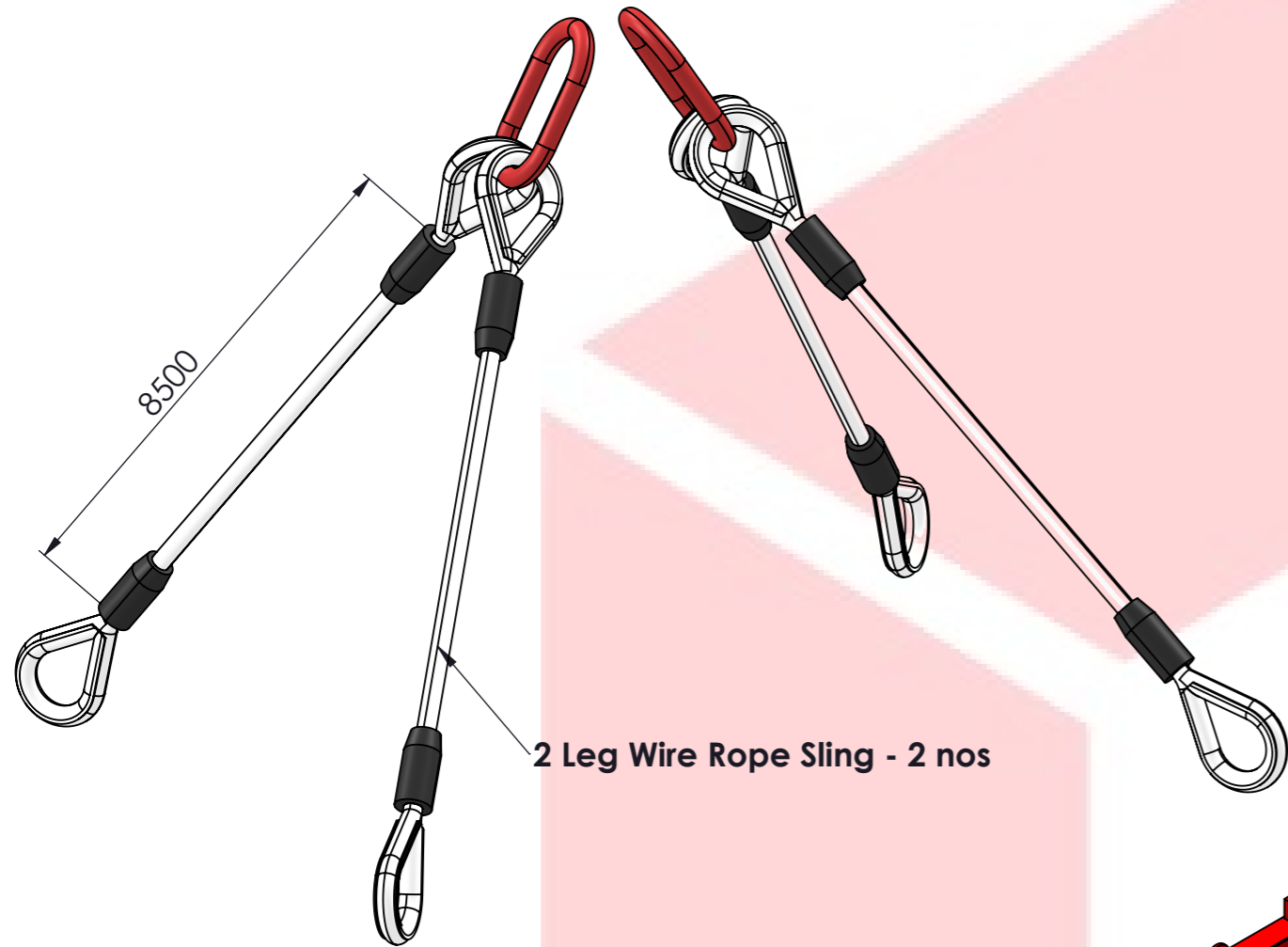

2 Leg Wire Rope Sling - 2 nos

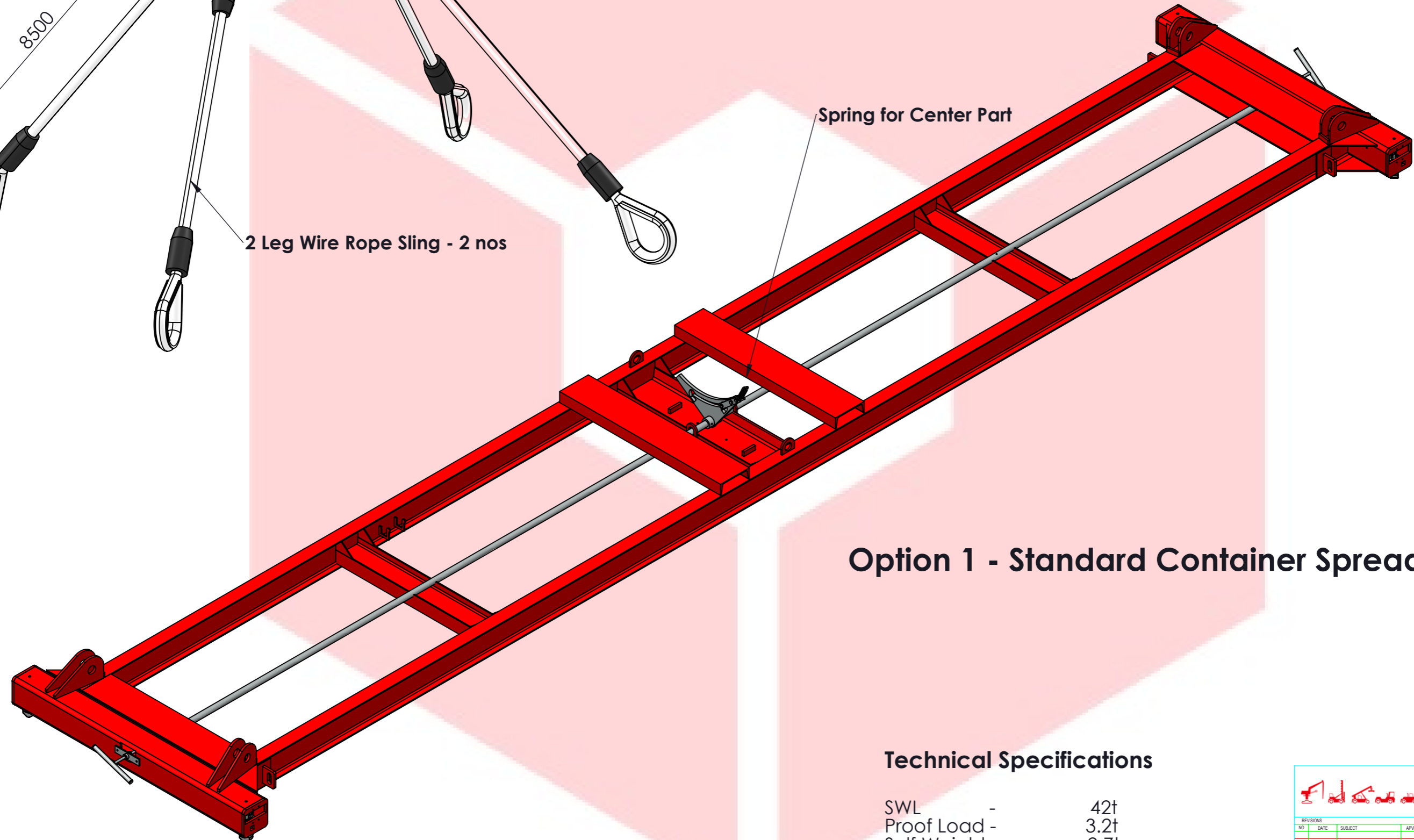

Spring for Center Part

## Option 1 - Standard Container Spreader

### Technical Specifications

SWL	-	42t
Proof Load	-	3.2t
Self Weight	-	2.7t
Paint	-	RAL 3020 (RED)
Sling Type	-	2 x 2 leg wire rope Sling

				42 T Container Spreader Length : 40 Ft	
REVISIONS NO. DATE SUBJECT		DRAWN : AMANDEEP SCALE : 1:100 CHECKED :		DATE : 10-10-2024 ORDER : - PRINCIPAL : CADNAME: EP106_42T PAGE 1 OF 5 PAGES	
				REV: 1 FORM: A3	
<small>DO NOT MEASURE ON THE DRAWING - ALL DIMENSIONS ARE IN MM                  This drawing can not be copied or given to other persons without written agreement. The drawing remains property of the company PRONK.</small>					

3 x Big Flippers

### Option 2 - With Big Flippers

3 x Small Flippers

Handle will be removed while using big flippers.

### Option 3 - With Small Flippers



42 T Container Spreader  
Length : 40 Ft

REVISIONS				DRAWN :	DATE :
NO	DATE	SUBJECT	APVD	AMANDEEP	10-10-2024
				SCALE :	ORDER :
				1:100	PRINCIPAL :
				CHECKED :	CADNAME: EP106_42T REV: 1
					PAGE 2 OF 5 PAGES FORM: A3

DO NOT MEASURE ON THE DRAWING - ALL DIMENSIONS ARE IN MM  
This drawing can not be copied or given to other persons without written agreement. The drawing remains property of the company PRONK.

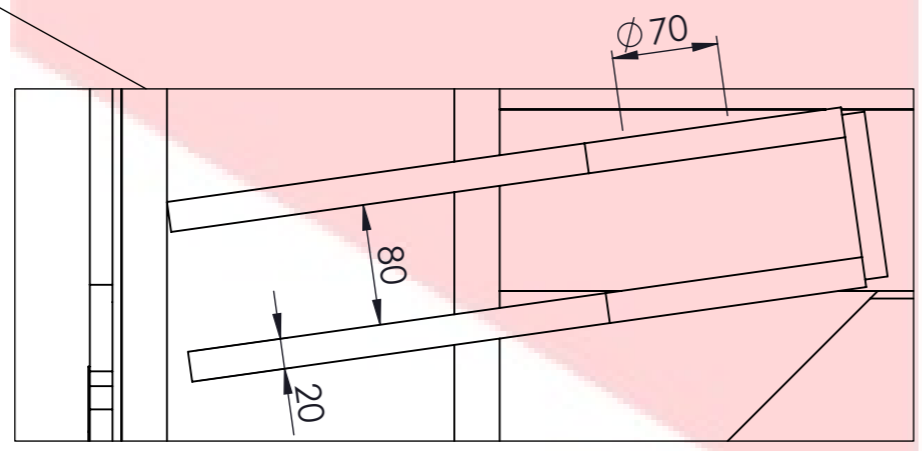
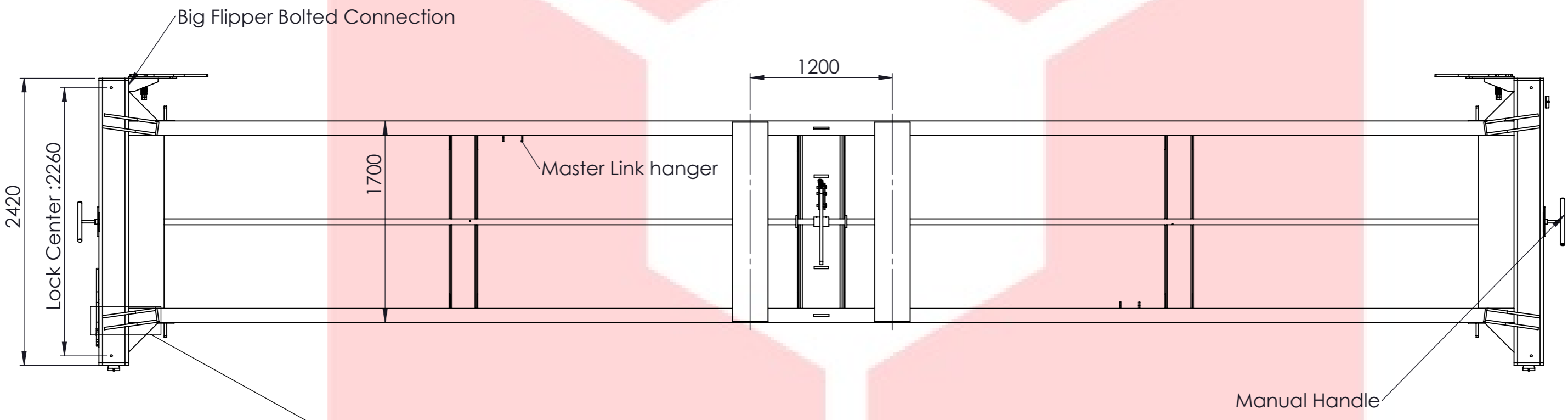
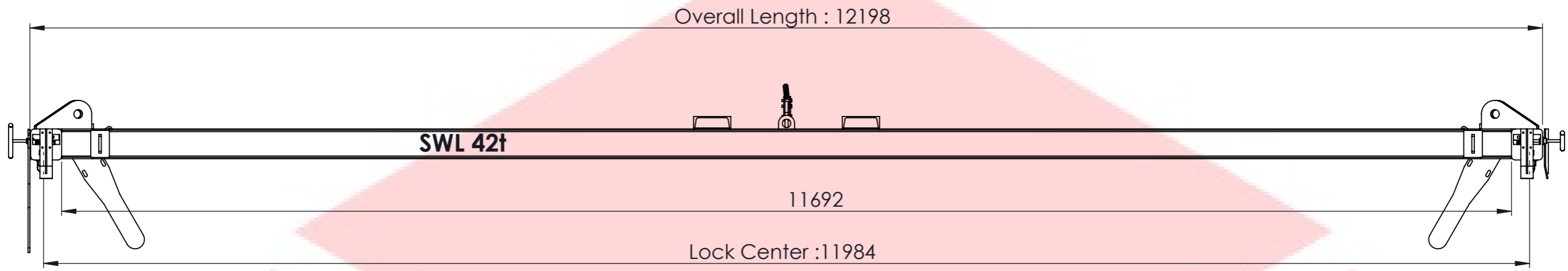

42 T Container Spreader  
Length : 40 Ft

REVISIONS				DRAWN : AMANDEEP	DATE : 10-10-2024
NO	DATE	SUBJECT	APVD	ORDER : -	PRINCIPAL :
				SCALE : 1:100	CADNAME: EP106_42T
				CHECKED :	REV: 1
				PAGE 3 OF 5 PAGES	FORM: A3

DO NOT MEASURE ON THE DRAWING - ALL DIMENSIONS ARE IN MM  
This drawing can not be copied or given to other persons without written agreement. The drawing remains property of the company PRONK.

Spreader width : 2420

Container Width : 2438

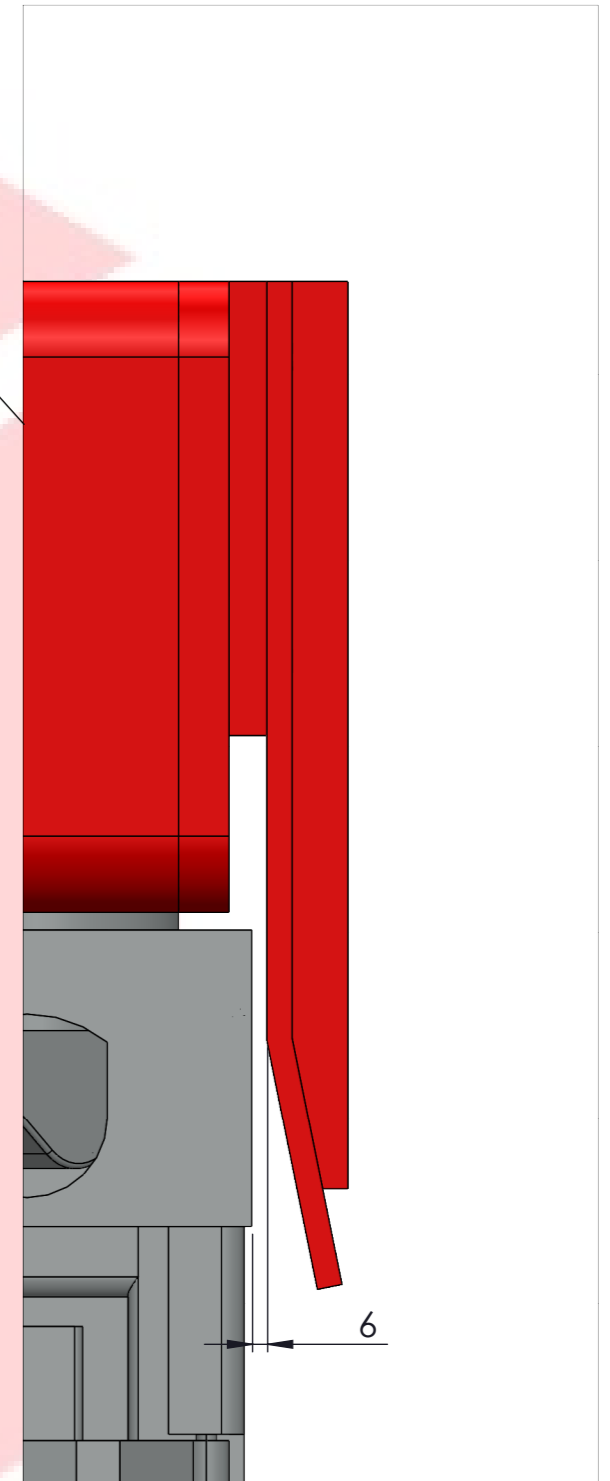
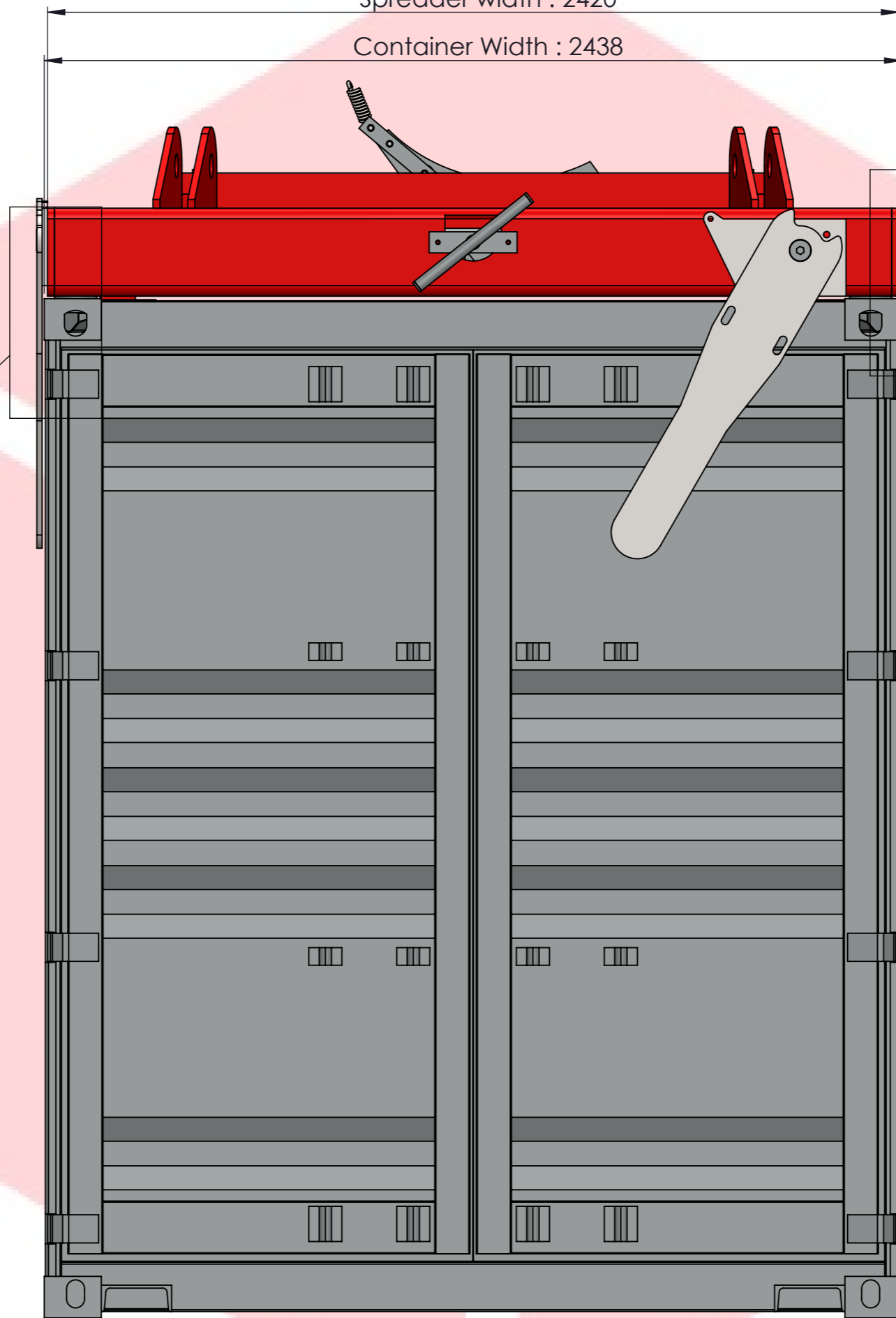
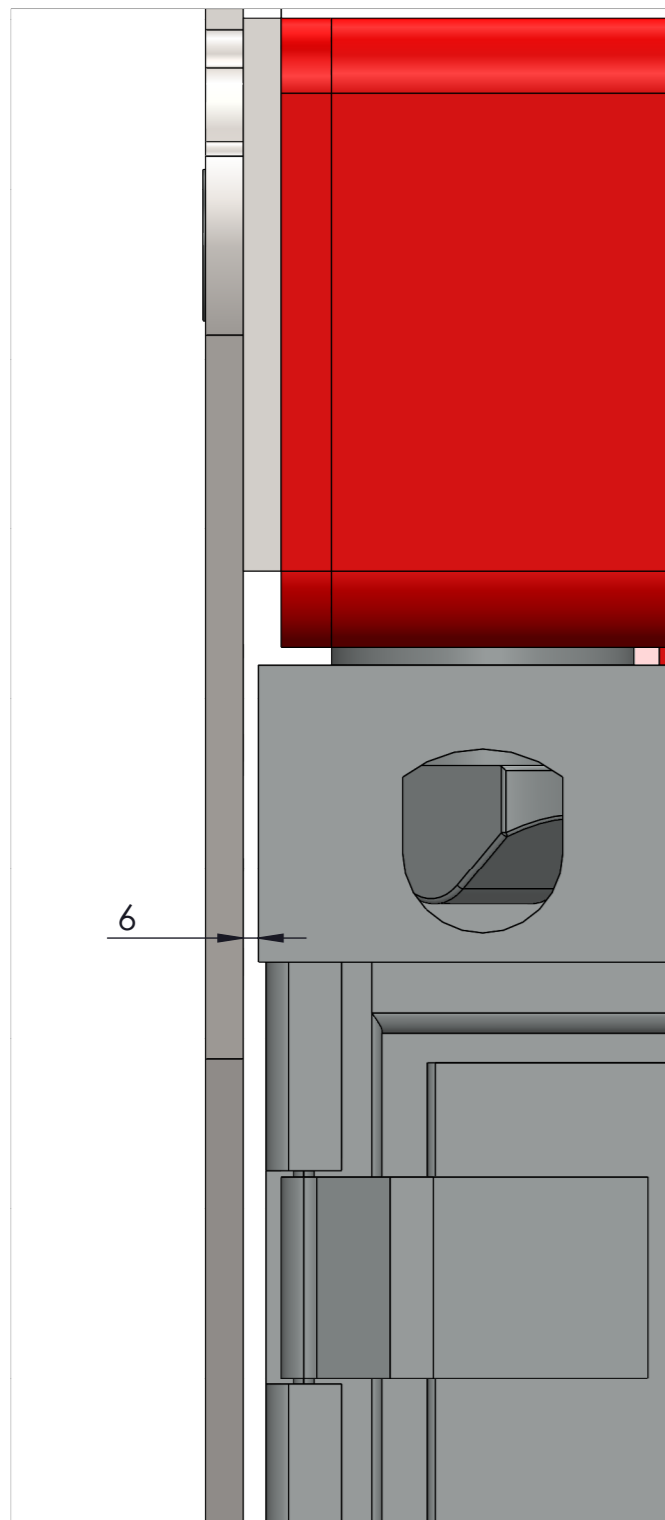

42 T Container Spreader  
Length : 40 Ft

REVISIONS				DRAWN :		DATE :	
NO	DATE	SUBJECT	APVD	AMANDEEP	10-10-2024	ORDER :	
						PRINCIPAL :	
						CADNAME: EP106_42T	REV: 1
						PAGE 4 OF 5 PAGES	FORM: A3

DO NOT MEASURE ON THE DRAWING - ALL DIMENSIONS ARE IN MM  
This drawing can not be copied or given to other persons without written agreement. The drawing remains property of the company PRONK.

Spreader Length : 12192  
 40ft Container Length : 12192

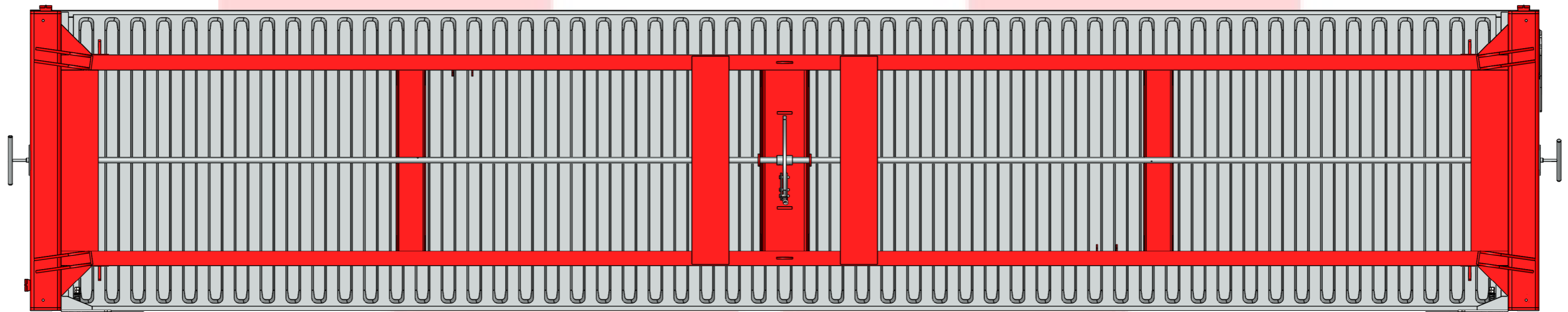
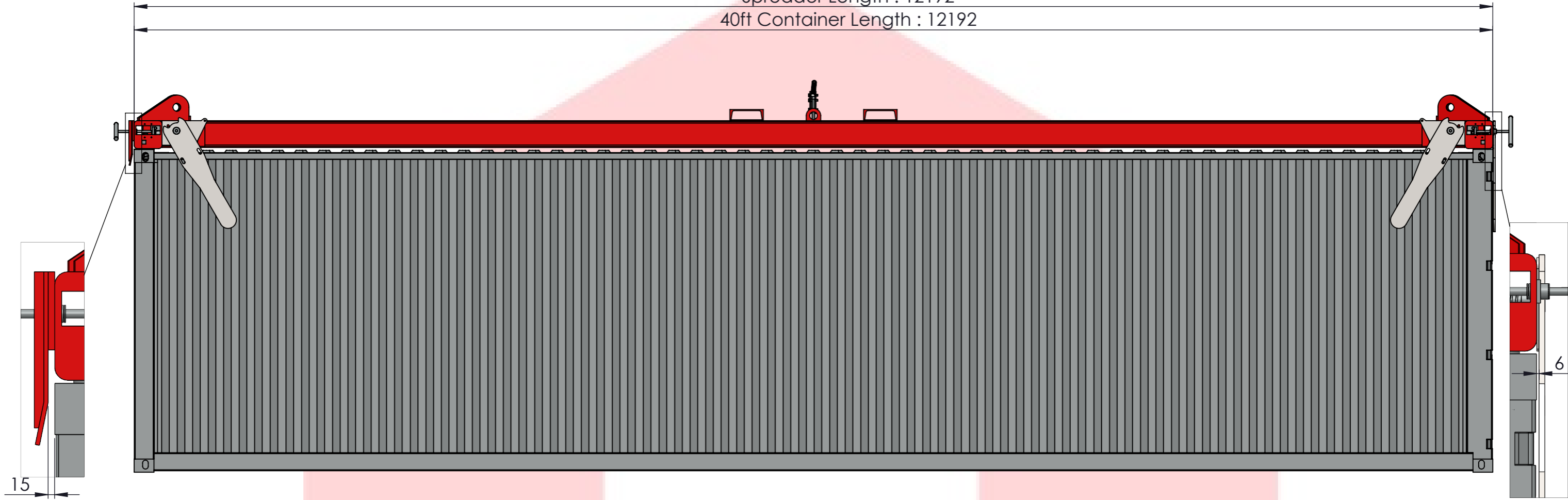

42 T Container Spreader  
 Length : 40 Ft

REVISIONS				DRAWN :		DATE :	
NO	DATE	SUBJECT	APD	AMANDEEP	10-10-2024	ORDER :	
						PRINCIPAL :	
						CADNAME: EP106_42T	REV: 1
						PAGE 5 OF 5 PAGES	FORM: A3

DO NOT MEASURE ON THE DRAWING - ALL DIMENSIONS ARE IN MM  
 This drawing can not be copied or given to other persons without written agreement. The drawing remains property of the company PRONK.